

BRAZED PLATE HEAT EXCHANGER

300kW*

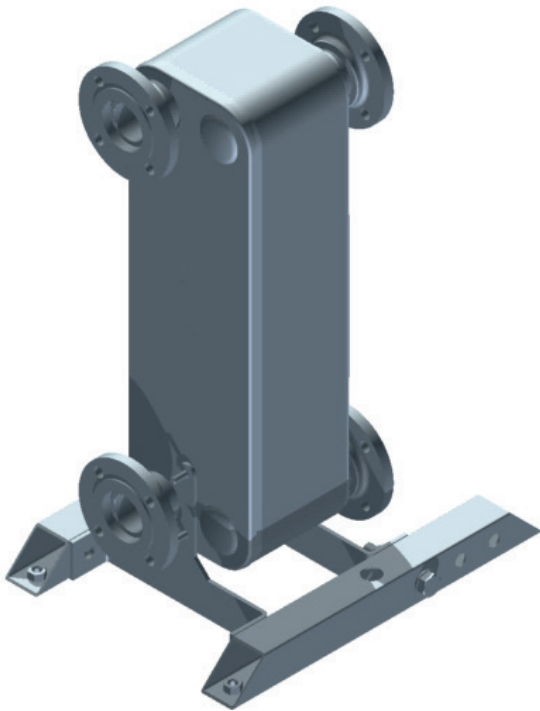

Covering outputs of 60, 150, 300, 450, 600, 750 and 900kW. Brazed Plate Heat Exchangers ensure optimum heat transfer efficiency and low resistance within a compact footprint. To be used with Ideal Commercial Frame and Header kits.

FEATURES & BENEFITS

- Compact design
- No gaskets
- Low maintenance and self-cleaning
- All units are pressure tested
- To be used with Ideal Commercial Frame and Header kits
- Ensures optimal heat transfer efficiency and pressure resistance
- Separates system water from the boiler
- Ensures the highest performance for longest possible service life

DIMENSIONS

The dimensions below represent the Plates only.



LENGTH
237mm



WIDTH
191mm



HEIGHT
616mm

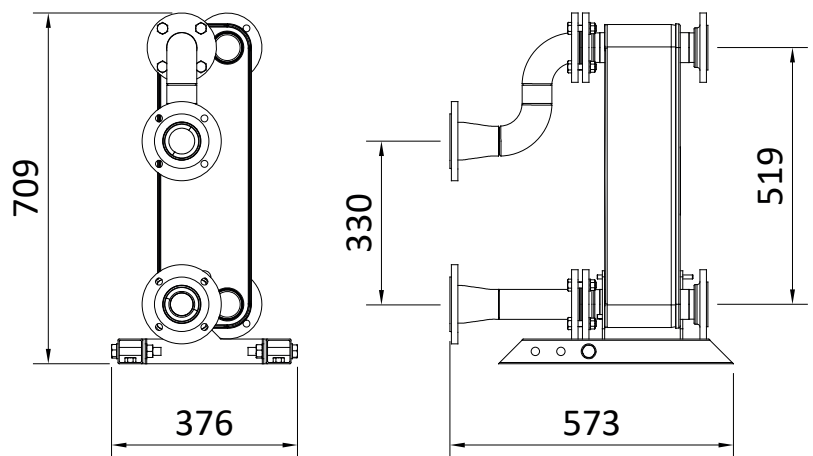

BRAZED PLATE HEAT EXCHANGER 300kW SPECIFICATIONS

TECHNICAL SPECIFICATION

		HOT SIDE	COLD SIDE
Mass flow rate	kg/s	3.590	3.590
Inlet temperature	°C	80.0	50.0
Outlet temperature	°C	60.0	70.0
Pressure drop	kPa	10.2	10.9
Heat exchanged	kW	300	
Heat transfer area	m ²	5.82	
Flow configuration		Countercurrent	
Number of plates / thickness		54 / 0.3 mm	
Number of passes		1	1
Pressure vessel code		PED	
Design pressure at 90.00 Celsius	Bar	30.0	30.0
Design pressure at 225.0 Celsius	Bar	25.0	25.0
Design temperature	°C	-196.0 / 225.0	
Overall length x width x height	mm	237 x 191 x 616	
Net weight, empty / operating	kg	25.3 / 36.2	

FRAME & HEADER CONNECTIONS

Low Height	DN65
Low Height	DN80
Standard Height	DN100

STANDARD MATERIALS

Cover plates	Stainless steel
Connections	Stainless steel
Plates	Stainless steel
Brazing	Copper

*This is the nominal capacity of the plate heat exchanger applying the operating conditions shown in this document. Please contact Ideal Commercial to confirm the expected performance if the operating conditions differ from those shown.

SYSTEM CONNECTIONS DN50

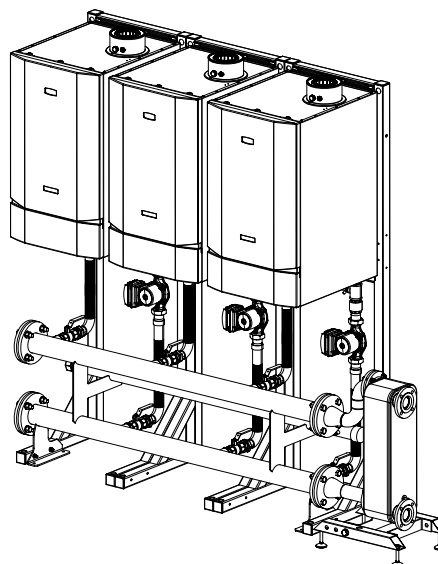

211383

GET A QUOTE

W: IDEALCOMMERCIALBOILERS.COM

E: commercial@idealboilers.com

T: 0844 543 6060