

IMAX XTRA

200kW

5 YEAR HEAT EXCHANGER WARRANTY*



The Imax Xtra range of condensing boilers is offered in six models with outputs from 80 to 280 kW suitable for floor standing application in either single or multiple applications.

FEATURES & BENEFITS

- Robust cast aluminium silicon alloy heat exchanger
- In-built commissioning and fault diagnostics
- Volt free contacts and BMS operation standard
- Meets Building Regulations (Part L2)
- Compact size - small footprint
- High 5:1 turndown
- Up to 107.5% net efficiency (fully condensing)
- Fits through standard doorways
- Conventional or room sealed flue options
- Direct weather compensation option
- NOx <40mg/kWh (Class 5) for maximum BREEAM points

DIMENSIONS & CLEARANCES

BOILER	DIM A	DIM B	DIM C
200	600	1150	1048

The following minimum clearances must be maintained for operation and servicing:

- ↑ TOP: 500mm
- FRONT: 600mm
- ↔ SIDES: LH 450mm | RH 150mm
- ↓ REAR: 700mm

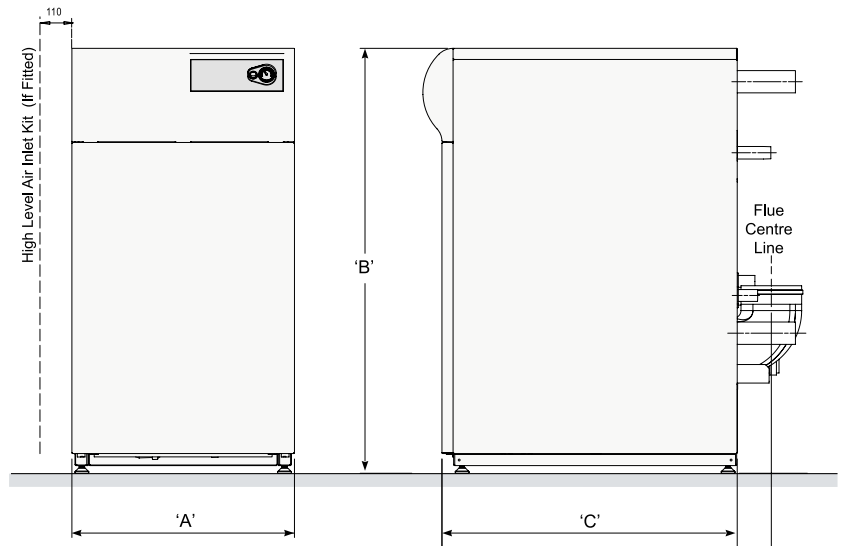

IMAX XTRA 200kW

TECHNICAL SPECIFICATIONS



GENERAL

Dry Weight	KG	198
Boiler Dimensions	mm	1150 (H) x 600 (W) x 1048 (D)
Boiler Clearances	mm	Front: 600 Left Side: 450 Right Side: 150 Rear: 700 Top: 500
Seasonal Efficiency	%	95.7
Min/Max Gas pressure (Nat Gas)	mbar	15-20

BURNER PRE MIX

Fuel	(Type G20)	Natural Gas
Fuel Consumption (Nat Gas)	m ³ /h	20.1
Flame Protection		Ionisation
Ignition		Spark
Boiler Output (Mean 70°C)	kW	43.1-196.6
Boiler Output (Mean 40°C)	kW	47.3-207.8
Boiler Input (Gross cv)	kW	221.1
Gas Inlet Size		G1"
NOx Rating/emissions at 0% O ₂	mg/kWh	Class 5 (26)

HYDRAULICS

Hydraulic Resistance (11°C ΔT)	mbar	314
Hydraulic Resistance (20°C ΔT)	mbar	95
Nominal Flow Rate (11°C ΔT)	l/s	4.51
Nominal Flow Rate (20°C ΔT)	l/s	2.48
Min Flow Rate (20°C ΔT) (MAX MOD)	l/s	0.496
Min Flow Temperature	°C	20
Max Flow Temperature	°C	90
Min Working Pressure	bar	0.3
Max Working Pressure	bar	6
Max Static Head Of Water	metres	61
Condensate Connection	mm	21.5
High Limit Set Point	°C	100 flow, 100 return 105 H/Ex
Flow & Return Size		G2"
Water Content	litres	18.4

FLUE/AIR INLET

Flue Size	mm	200
Flue Gas Volume	m ³ /h	302.0
Flue Gas Temperature 80/60	°C	80
Max Flue Resistance	Pa	150

ELECTRICAL

Electrical Supply		230/240V 50Hz 1 Ph
Current (Max No Pump)	amp	1.95
Power Consumption	watt	400
Modulating Input	V/dc	0-10V
Fuse Rating	amp	5
Controls Voltage	V	24 or 240
Insulation Class IP		IP20

CONTROL OPERATION

On/Off 0-10V DC	Yes
OpenTherm	No
High Limit Protection	Yes
Low Water Protection	Yes
Volt Free Common Alarm	Yes
Boiler Run Indication	Yes

OPTIONAL EXTRAS

Modulating Sequencer Control for controlling multiple boiler installations	Yes
Programmable Room Thermostat	Yes
Outside Sensor Kit	Yes
Tank Sensor Kit	Yes
Room Sensor Kit	Yes
Sequencer DHW Sensor Kit	Yes
Flow, Return and Gas Header Kit	N/A
RS Air Duct Connector	N/A
Horizontal Flue Connector	N/A
Vertical Flue Connector	N/A



*5 year heat exchanger warranty subject to terms and conditions. Terms & conditions available at www.idealcommercialboilers.com/downloads.
2 year parts and labour warranty as standard.

GET A QUOTE

W: IDEALCOMMERCIALBOILERS.COM
E: commercial@idealboilers.com
T: 0844 5436060

OVERVIEW

The boilers must be fully automatically controlled, floor standing, fanned, super-efficient condensing appliances utilising an aluminium silicon alloy heat exchanger and be suitable for connection to fully pumped open vented or sealed water systems.

CONTROLS

The condensing boilers must have connectivity for common types of BMS integration including 0-10v & volt free connections. Where no BMS is present a modulating sequencer must be available.

The boiler must be fully modulating with a 5:1 turndown ratio and include control features enabling set point adjustment, heating circuit control of one constant temperature and one DHW circuit or 2 constant temperature circuits, and safety lock out parameters including fault diagnosis for both boiler and external components such as sensors or pumps.

Boiler capabilities must include, with the use of external components, frost protection, weather or room compensation and system pump control.

FLUE

The condensing boilers must be suitable for use with a room sealed flue or open flue applications including C13, C33 and B23 classifications. The flue outlet and air inlet must be situated at the rear of the boiler.

HYDRAULIC

The condensing boiler must be suitable for connection to fully pumped open vented or sealed water systems. All hydraulic connections including flow return and condensate drain must be located on the rear of the boiler. Hydraulic connections must be uniform across the outputs available in the range to ensure ease of installation and maintenance in mixed output cascades.

The boiler must have a maximum operating pressure of 6 bar and be suitable for heating and indirect hot water systems.

DIMENSIONS

The condensing boiler must fit within maximum permitted floor space of 0.48m² (80 - 160kW models) or 0.63m² (200 - 280kW models).

MOUNTING / POSITIONING

The condensing boilers will be floor standing.

EFFICIENCY

The condensing boilers are capable of high seasonal efficiencies with a minimum requirement of 95.7% and low NOx emissions no greater than 35mg/kWh.

APPROVALS

The boilers must be tested and certified by Gastec to EN483 and EN677 for use with Natural Gas.

Boilers are certified to meet the requirements of the EC Gas Appliance Directive, Boiler Efficiency Directive, EMC and Low Voltage Directive.

The manufacturer must be ISO 9001 accredited.

SPECIFICATION

The boiler will be capable of flow rates for common systems using 11°C to 20°C temperature differentials.

SOURCING

The condensing boiler must be manufactured or finally assembled in the United Kingdom.

WARRANTY

The boiler must be available with a 2 year warranty.